

MURRELEKTRONIK DRIVES PROGRAMM

Anschlussleitungen für **SIEMENS SINAMICS S120** - Antriebssysteme

Umspritzt, was sonst?





PASSENDE ANTRIEBSMOTOREN FÜR DIE SINAMICS S120



1FT7



1FK7

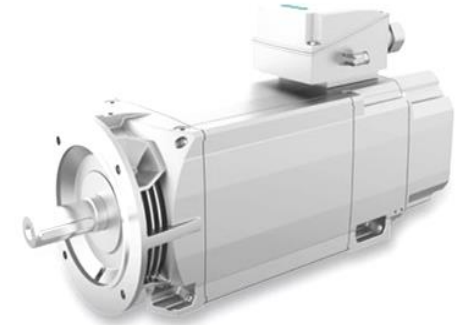

1PH8

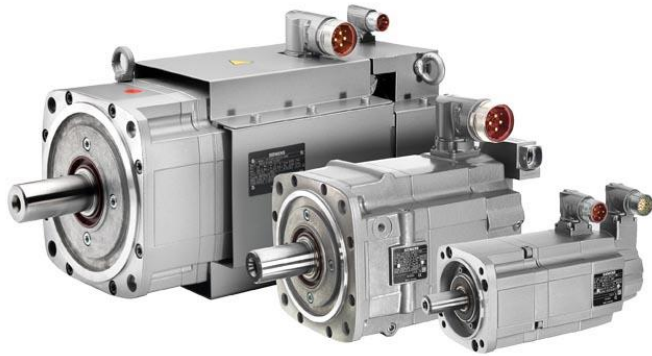



PASSENDE MURRELEKTRONIK ANSCHLUSSTECHNIK

SINAMICS S120

Motoranschlusseite

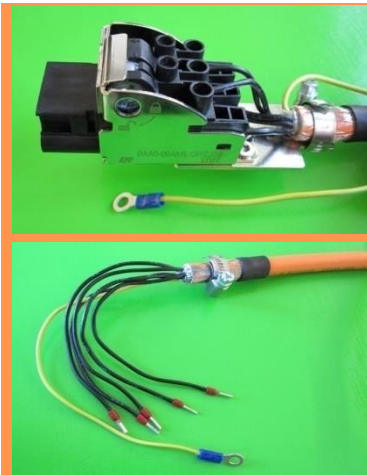

POWER

Leistungsstecker

offenes
Leitungsende,
konfektioniert

M23 Stecker
(Größe 1)



SIGNAL

Drive CLiQ (IP20)

Drive CLiQ (IP67)

SUB-D Stecker



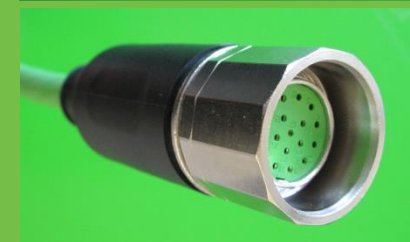





M23 Stecker
(Größe 1)





WIR HABEN SIE ALLE! – GEBER (SIGNAL) KOMPLETTES PRODUKTPORTFOLIO FÜR DIE SINAMICS S120







- schnell, flexibel - in höchster Qualität

DriveCliqu-Leitungen	ME-Art.-Nr:	Siemens-Nr.
	7000-SS041-880xxxx	6FX8002-2DC00-xxxx
	7000-SS051-880xxxx	6FX8002-2DC10-xxxx
	7000-SS061-880xxxx	6FX8002-2DC20-xxxx
M23-Signal-Leitung		
	7000-SS171-882xxx	6FX8002-2AD04-xxxx
	7000-SS261-811xxxx	6FX8002-2CA31-xxxx
	7000-SS265-811xxxx	6FX8002-2CA34-xxxx
	7000-SS211-882xxx	6FX8002-2CH00-xxxx
	7000-SS161-811xxxx	6FX8002-2EQ10-xxxx
	7000-SS165-811xxxx	6FX8002-2EQ14-xxxx



WIR HABEN SIE ALLE! – SERVO (POWER) KOMPLETTES PRODUKTPORTFOLIO FÜR DIE SINAMICS S120

- schnell, flexibel - in höchster Qualität

M23-Power-Leitung	ME-Art.-Nr:	Siemens-Nr.
	7000-PS011-821xxxx	6FX8002-5DS01-xxxx
	7000-PS011-833xxxx	6FX8002-5DS11-xxxx
	7000-PS201-821xxxx	6FX8002-5DA01-xxxx
	7000-PS201-833xxxx	6FX8002-5DA11-xxxx
	7000-PS101-821xxxx	6FX8002-5DA05-xxxx
	7000-PS101-833xxxx	6FX8002-5DA15-xxxx

Transparente Artikelnummern

Die Siemens-Bezeichnungen gehen 1:1 in die Murrelektronik-Bezeichnungen ein und sorgen so für eine unkomplizierte Umschlüsselung.



Siemensbezeichnung:

6FX8002-2DC10

Murrelektronik Bezeichnung:

M6FX8002-2DC10

WIR KENNEN UNSEREN WETTBEWERB

Eigenschaften	Siemens	Igus	Lapp	Sangel	Helu	Murrelektronik
mögl. Kabelfarben Kabelmaterial	OR, GN PUR, PVC	OR, GN PUR, PVC	OR, GN PUR, PVC	OR, GN PUR, PVC	OR, GN PUR, PVC	OR, GN PUR
Steckergehäuse Schutzart	Metall IP67	Metall PUR ummantelt IP67	Metall IP68	Metall IP68	Metall / metal IP67	PUR IP67
Baugrößen	M17, M23, M40, DriveCliq, speed connect	M17, M23, M40, M58, DriveCliq, speed connect	M23, M40, M58, DriveCliq	M17, M23, M40, M58, DriveCliq spring tec	M17, M23, M40, spread connect	M23 Buchse/ DriveCliq
Hersteller	Siemens	B&R, Beckhoff, Siemens, SEW, Rexroth, Fanuc, Baumüller, etc.	Siemens, Indramat, Lenze, SEW	Siemens, Indramat, Lenze, SEW	B&R, Beckhoff, Siemens, SEW, Rexroth, Fanuc, Baumüller, etc.	Siemens
Rastsicherung	NEIN	NEIN	NEIN	NEIN	NEIN	JA
Schlüsselfläche	NEIN	NEIN	NEIN	NEIN	NEIN	JA
Schlauchanschluß	NEIN	NEIN	NEIN	NEIN	NEIN	JA
Listenpreis (10 m)						
6FX8002-2CA31-1BA0 	111,68 €	137,43 €	97,37 €	65,64 €	174,00 €	128,95 €
6FX8002-5DS01-1BA0 	198,78 €	167,09 €	172,97 €	78,45 €	267,00 €	200,75 €
6FX8002-5DA01-1BA0 	139,35 €	139,75 €	102,20 €	64,22 €	166,00 €	128,00 €