

16A Metal hoods/housings

Degree of protection: IP65

Hoods, side entry



| Thread | Designation | Order No. |
|--------|-----------------|-------------|
| M20 | H16A-SE-2B-M20 | 02016141210 |
| PG16 | H16A-SE-2B-PG16 | 02016143510 |

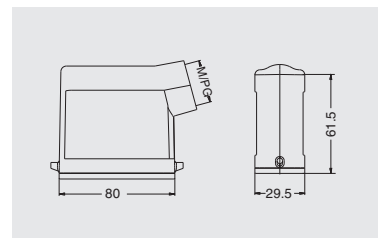

Hoods, side entry, high construction



| Thread | Designation | Order No. |
|--------|------------------|-------------|
| M25 | H16A-SEH-2B-M25 | 02016341310 |
| PG16 | H16A-SEH-2B-PG16 | 02016343510 |
| PG21 | H16A-SEH-2B-PG21 | 02016343610 |

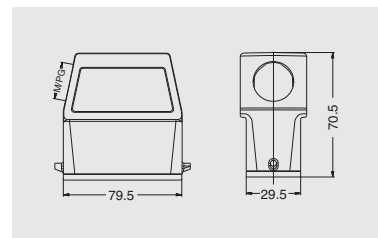

Hoods, top entry



| Thread | Designation | Order No. |
|--------|-----------------|-------------|
| M20 | H16A-TE-2B-M20 | 02016241210 |
| PG16 | H16A-TE-2B-PG16 | 02016243510 |

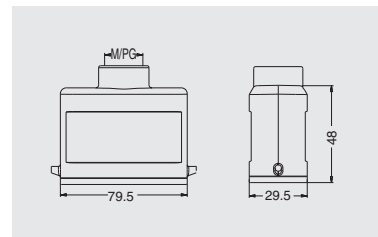

Hoods, top entry, high construction



| Thread | Designation | Order No. |
|--------|------------------|-------------|
| M25 | H16A-TEH-2B-M25 | 02016441310 |
| PG16 | H16A-TEH-2B-PG16 | 02016443510 |
| PG21 | H16A-TEH-2B-PG21 | 02016443610 |

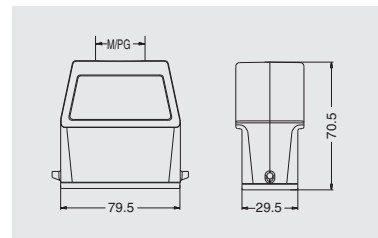

Housings, bulkhead mounting



| Thread | Designation | Order No. |
|--------|---------------------------------------|-------------|
| -- | H16A-BK-1L/PSR with plastic cover | 02016010052 |
| -- | H16A-BK-1L/PSR-CV with metal cover | 02016010063 |
| -- | H16A-BK-1L/PSR-MCV | 02016010064 |

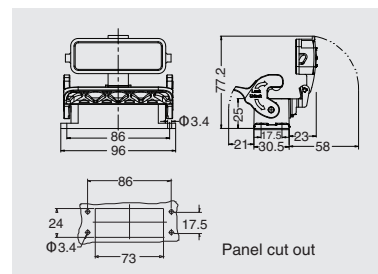

Please refer to page 16-02 for choosing proper model of lock.

16A Metal hoods/housings

Degree of protection: IP65

Housings, surface mounting



| Thread | Designation | Order No. |
|--------------------|--------------------------|-------------|
| M20 | H16A-SF-1L/PSR-M20 | 02016511252 |
| 2M20 | H16A-SF-1L/PSR-2M20 | 02016516252 |
| M25 | H16A-SF-1L/PSR-M25 | 02016511352 |
| 2M25 | H16A-SF-1L/PSR-2M25 | 02016516352 |
| PG16 | H16A-SF-1L/PSR-PG16 | 02016513552 |
| 2PG16 | H16A-SF-1L/PSR-2PG16 | 02016518552 |
| PG21 | H16A-SF-1L/PSR-PG21 | 02016513652 |
| with plastic cover | | |
| M20 | H16A-SF-1L/PSR-CV-M20 | 02016511263 |
| 2M20 | H16A-SF-1L/PSR-CV-2M20 | 02016516263 |
| M25 | H16A-SF-1L/PSR-CV-M25 | 02016511363 |
| 2M25 | H16A-SF-1L/PSR-CV-2M25 | 02016516363 |
| PG16 | H16A-SF-1L/PSR-CV-PG16 | 02016513563 |
| 2PG16 | H16A-SF-1L/PSR-CV-2PG16 | 02016518563 |
| PG21 | H16A-SF-1L/PSR-CV-PG21 | 02016513663 |
| with metal cover | | |
| M20 | H16A-SF-1L/PSR-MCV-M20 | 02016511264 |
| 2M20 | H16A-SF-1L/PSR-MCV-2M20 | 02016516264 |
| M25 | H16A-SF-1L/PSR-MCV-M25 | 02016511364 |
| 2M25 | H16A-SF-1L/PSR-MCV-2M25 | 02016516364 |
| PG16 | H16A-SF-1L/PSR-MCV-PG16 | 02016513564 |
| 2PG16 | H16A-SF-1L/PSR-MCV-2PG16 | 02016518564 |
| PG21 | H16A-SF-1L/PSR-MCV-PG21 | 02016513664 |

Please refer to page 16-02 for choosing proper model of lock.

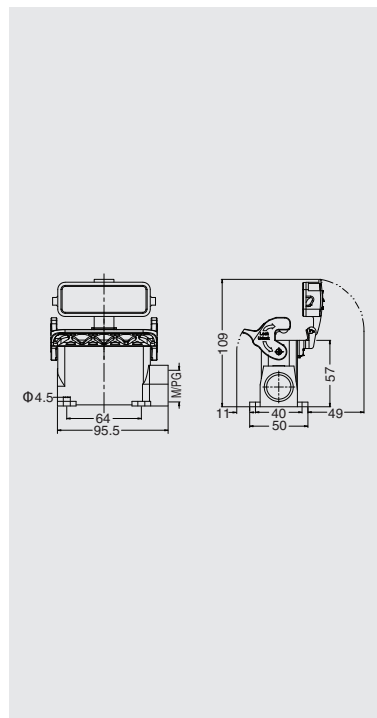

Protection covers, metal cover



| Connect way | Applications | Designation | Order No. |
|-------------|--------------|-------------------|-------------|
| | for hoods | H16A-MCV-1L/PSR.1 | 08139121002 |

Please refer to page 16-02 for choosing proper model of lock.

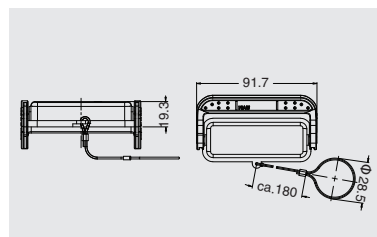

Protection covers, metal cover



| Connect way | Applications | Designation | Order No. |
|-------------|--------------|----------------|-------------|
| | for housings | H16A-MCV-2B/1S | 08139120100 |
| | for housings | H16A-MCV-2B/2S | 08139120000 |

