

16B Plastic hoods/housings

Degree of protection: IP65

Hoods, side entry, high construction



Thread	Designation	Order No.
M40	H16B.P-SEH-4B-M40	03P16381510

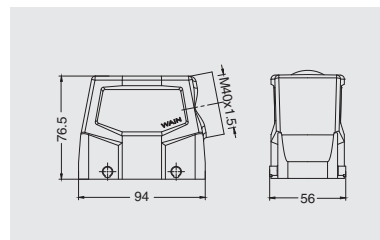

Housings, bulkhead mounting



Thread	Designation	Order No.
--	H16B.P-BK-2L	03P16020010

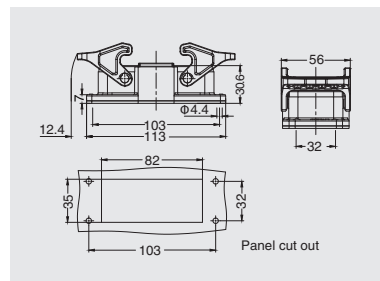

16B Metal hoods/housings

Degree of protection: IP65

Hoods, side entry



Thread	Designation	Order No.
M25	H16B-SE-2B-M25	03016141310
PG21	H16B-SE-2B-PG21	03016143610

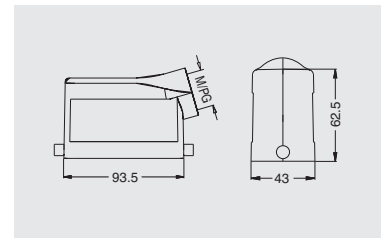

Hoods, side entry, high construction



Thread	Designation	Order No.
M32	H16B-SEH-2B-M32	03016341410
M40	H16B-SEH-2B-M40	03016341510
PG21	H16B-SEH-2B-PG21	03016343610
PG29	H16B-SEH-2B-PG29	03016343710

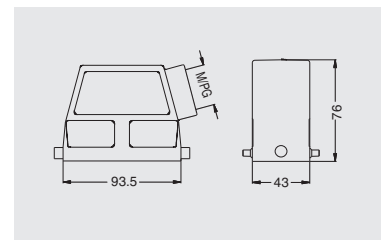

Hoods, top entry



Thread	Designation	Order No.
M25	H16B-TE-2B-M25	03016241310
M32	H16B-TE-2B-M32	03016241410
PG21	H16B-TE-2B-PG21	03016243610

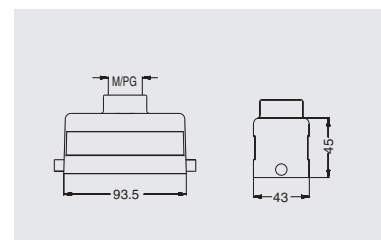

Hoods, top entry, high construction



Thread	Designation	Order No.
M32	H16B-TEH-2B-M32	03016441410
M40	H16B-TEH-2B-M40	03016441510
PG21	H16B-TEH-2B-PG21	03016443610
PG29	H16B-TEH-2B-PG29	03016443710

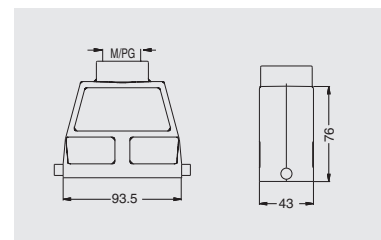

Housings, cable to cable



Thread	Designation	Order No.
M25	H16B-CCT-1L/PSR-M25	03016711352
PG21	H16B-CCT-1L/PSR-PG21	03016713652

Please refer to page 16-02 for choosing proper model of lock.

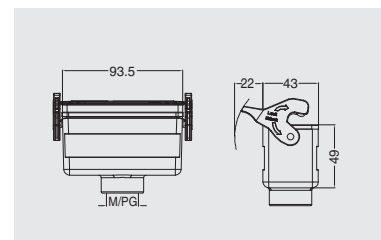

Housings, cable to cable high construction



Thread	Designation	Order No.
M32	H16B-CCTH-1L/PSR-M32	03016811452
M40	H16B-CCTH-1L/PSR-M40	03016811552
PG21	H16B-CCTH-1L/PSR-PG21	03016813652
PG29	H16B-CCTH-1L/PSR-PG29	03016813752

Please refer to page 16-02 for choosing proper model of lock.

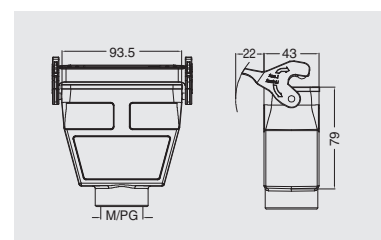

16B Metal hoods/housings

Degree of protection: IP65

Housings, bulkhead mounting



Thread	Designation	Order No.
---	H16B-BK-1L/PSR	03016010052
	with plastic cover	
---	H16B-BK-1L/PSR-CV	03016010062
	with metal cover	
---	H16B-BK-1L/PSR-MCV	03016010063

Please refer to page 16-02 for choosing proper model of lock.

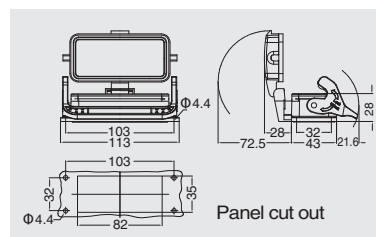

Panel cut out

Housings, surface mounting



Thread	Designation	Order No.
M25	H16B-SF-1L/PSR-M25	03016511352
2M25	H16B-SF-1L/PSR-2M25	03016516352
PG21	H16B-SF-1L/PSR-PG21	03016513652
2PG21	H16B-SF-1L/PSR-2PG21	03016518652
	with plastic cover	
M25	H16B-SF-1L/PSR-CV-M25	03016511363
2M25	H16B-SF-1L/PSR-CV-2M25	03016516363
PG21	H16B-SF-1L/PSR-CV-PG21	03016513663
2PG21	H16B-SF-1L/PSR-CV-2PG21	03016518663
	with metal cover	
M25	H16B-SF-1L/PSR-MCV-M25	03016511364
2M25	H16B-SF-1L/PSR-MCV-2M25	03016516364
PG21	H16B-SF-1L/PSR-MCV-PG21	03016513664
2PG21	H16B-SF-1L/PSR-MCV-2PG21	03016518664

Please refer to page 16-02 for choosing proper model of lock.

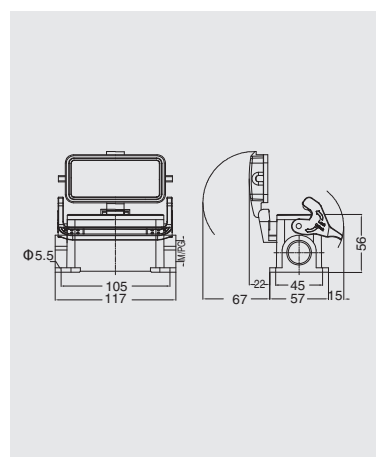

Housings, surface mounting

high construction



Thread	Designation	Order No.
M32	H16B-SFH-1L/PSR-M32	03016611452
2M32	H16B-SFH-1L/PSR-2M32	03016616452
PG21	H16B-SFH-1L/PSR-PG21	03016613652
2PG21	H16B-SFH-1L/PSR-2PG21	03016618652
PG29	H16B-SFH-1L/PSR-PG29	03016613752
2PG29	H16B-SFH-1L/PSR-2PG29	03016618752
	with plastic cover	
M32	H16B-SFH-1L/PSR-CV-M32	03016611463
2M32	H16B-SFH-1L/PSR-CV-2M32	03016616463
PG21	H16B-SFH-1L/PSR-CV-PG21	03016613663
2PG21	H16B-SFH-1L/PSR-CV-2PG21	03016618663
PG29	H16B-SFH-1L/PSR-CV-PG29	03016613763
2PG29	H16B-SFH-1L/PSR-CV-2PG29	03016618763
	with metal cover	
M32	H16B-SFH-1L/PSR-MCV-M32	03016611464
2M32	H16B-SFH-1L/PSR-MCV-2M32	03016616464
PG21	H16B-SFH-1L/PSR-MCV-PG21	03016613664
2PG21	H16B-SFH-1L/PSR-MCV-2PG21	03016618664
PG29	H16B-SFH-1L/PSR-MCV-PG29	03016613764
2PG29	H16B-SFH-1L/PSR-MCV-2PG29	03016618764

Please refer to page 16-02 for choosing proper model of lock.

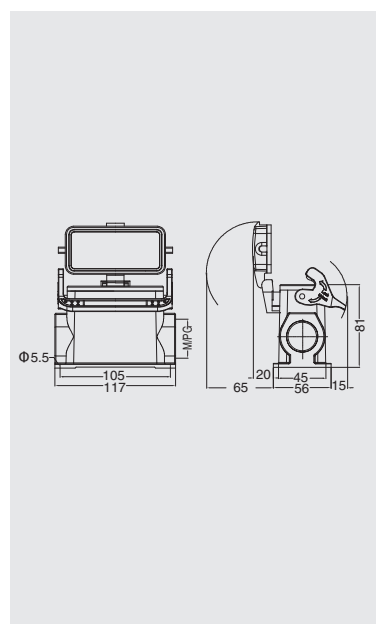

16B Metal hoods/housings

Degree of protection: IP65

Hoods, side entry



Thread	Designation	Order No.
M25	H16B-SE-4B-M25	03016181310
M32	H16B-SE-4B-M32	03016181410
PG21	H16B-SE-4B-PG21	03016183610

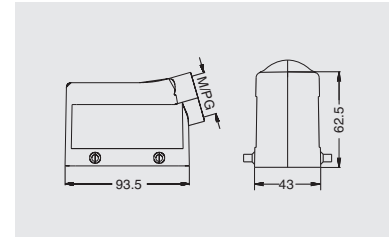

Hoods, side entry, high construction



Thread	Designation	Order No.
M32	H16B-SEH-4B-M32	03016381410
M40	H16B-SEH-4B-M40	03016381510
PG21	H16B-SEH-4B-PG21	03016383610
PG29	H16B-SEH-4B-PG29	03016383710

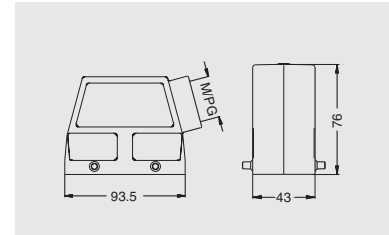

Hoods, top entry



Thread	Designation	Order No.
M25	H16B-TE-4B-M25	03016281310
PG21	H16B-TE-4B-PG21	03016283610

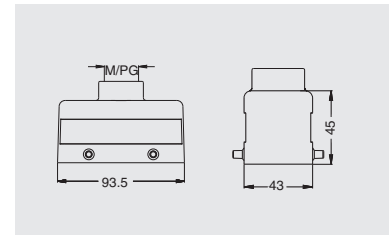

Hoods, top entry, high construction



Thread	Designation	Order No.
M32	H16B-TEH-4B-M32	03016481410
M40	H16B-TEH-4B-M40	03016481510
PG21	H16B-TEH-4B-PG21	03016483610
PG29	H16B-TEH-4B-PG29	03016483710

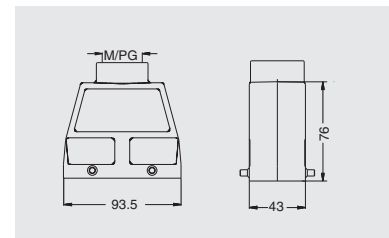

Housings, bulkhead mounting



Thread	Designation	Order No.
--	H16B-BK-2L/PSR	03016020052

Please refer to page 16-02 for choosing proper model of lock.

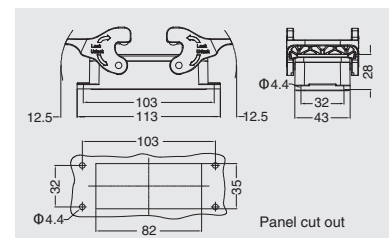

Housings, surface mounting



Thread	Designation	Order No.
M25	H16B-SF-2L/PSR-M25	03016521352
2M25	H16B-SF-2L/PSR-2M25	03016526352
PG21	H16B-SF-2L/PSR-PG21	03016523652
2PG21	H16B-SF-2L/PSR-2PG21	03016528652

Please refer to page 16-02 for choosing proper model of lock.

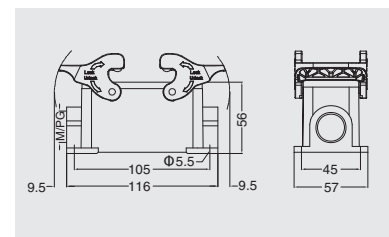

16B Metal hoods/housings

Degree of protection: IP65

Housings, surface mounting

high construction



Thread	Designation	Order No.
M32	H16B-SFH-2L/PSR-M32	03016621452
2M32	H16B-SFH-2L/PSR-2M32	03016626452
PG21	H16B-SFH-2L/PSR-PG21	03016623652
2PG21	H16B-SFH-2L/PSR-2PG21	03016628652
PG29	H16B-SFH-2L/PSR-PG29	03016623752
2PG29	H16B-SFH-2L/PSR-2PG29	03016628752

Please refer to page 16-02 for choosing proper model of lock.

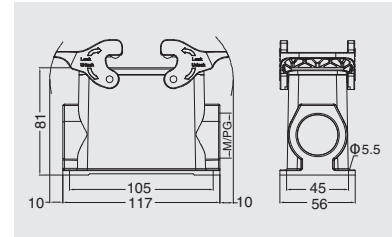

Housings, cable to cable



Thread	Designation	Order No.
M25	H16B-CCT-2L/PSR-M25	03016721352
PG21	H16B-CCT-2L/PSR-PG21	03016723652

Please refer to page 16-02 for choosing proper model of lock.

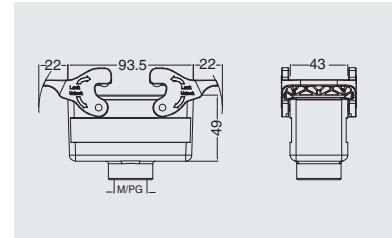

Housings, cable to cable

high construction



Thread	Designation	Order No.
M32	H16B-CCTH-2L/PSR-M32	03016821452
M40	H16B-CCTH-2L/PSR-M40	03016821552
PG21	H16B-CCTH-2L/PSR-PG21	03016823652
PG29	H16B-CCTH-2L/PSR-PG29	03016823752

Please refer to page 16-02 for choosing proper model of lock.

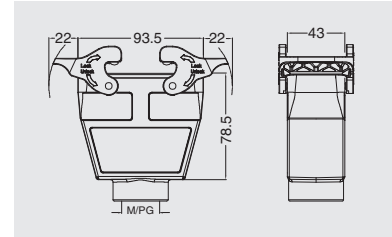

Protection covers, plastic



Connect way	Application	Designation	Order No.
---	for hoods	H16B-CV-4C	08221233000

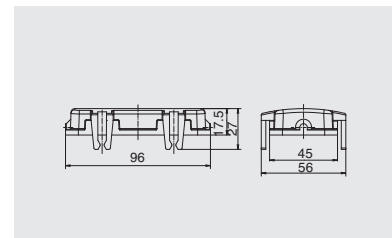

Protection covers, plastic



Connect way	Application	Designation	Order No.
	for hoods	H16B-CV-4B/1	08221232011
	for housings	H16B-CV-4B/2	08221232020

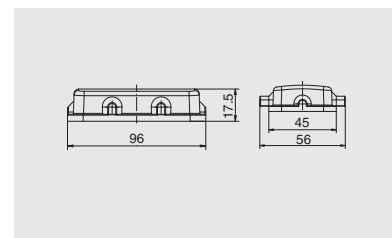

16B Metal hoods/housings

Degree of protection: IP65

Hoods, side entry



Thread	Designation	Order No.
M25	H16B-SE-2L/PSR-M25	03016121352
M32	H16B-SE-2L/PSR-M32	03016121452
PG21	H16B-SE-2L/PSR-PG21	03016123652

Please refer to page 16-02 for choosing proper model of lock.

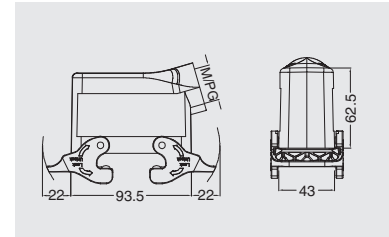

Hoods, side entry, high construction



Thread	Designation	Order No.
M32	H16B-SEH-2L/PSR-M32	03016321452
M40	H16B-SEH-2L/PSR-M40	03016321552
PG21	H16B-SEH-2L/PSR-PG21	03016323652
PG29	H16B-SEH-2L/PSR-PG29	03016323752

Please refer to page 16-02 for choosing proper model of lock.

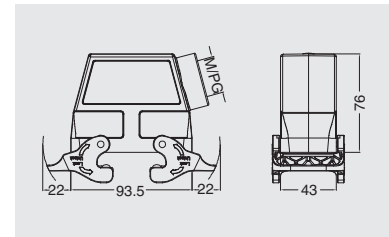

Hoods, top entry



Thread	Designation	Order No.
M25	H16B-TE-2L/PSR-M25	03016221352
PG21	H16B-TE-2L/PSR-PG21	03016223652

Please refer to page 16-02 for choosing proper model of lock.

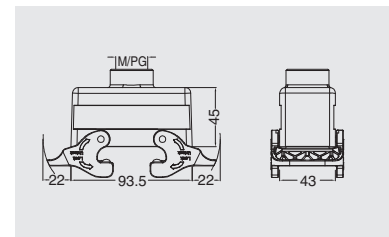

Hoods, top entry, high construction



Thread	Designation	Order No.
M32	H16B-TEH-2L/PSR-M32	03016421452
M40	H16B-TEH-2L/PSR-M40	03016421552
PG21	H16B-TEH-2L/PSR-PG21	03016423652
PG29	H16B-TEH-2L/PSR-PG29	03016423752

Please refer to page 16-02 for choosing proper model of lock.

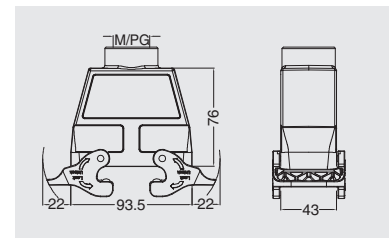

Housings, bulkhead mounting



Thread	Designation	Order No.
---	H16B-BK-4B	03016080010
	with plastic cover	
	H16B-BK-4B-CV	03016080020
	with metal cover	
	H16B-BK-4B-MCV	03016080021

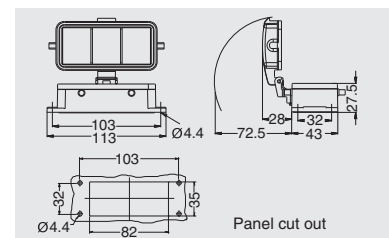

16B Metal hoods/housings

Degree of protection: IP65

Housings, surface mounting



Thread	Designation	Order No.
M25	H16B-SF-4B-M25	03016581310
2M25	H16B-SF-4B-2M25	03016586310
PG21	H16B-SF-4B-PG21	03016583610
2PG21	H16B-SF-4B-2PG21	03016588610
with plastic cover		
M25	H16B-SF-4B-CV-M25	03016581320
2M25	H16B-SF-4B-CV-2M25	03016586320
PG21	H16B-SF-4B-CV-PG21	03016583620
2PG21	H16B-SF-4B-CV-2PG21	03016588620
with metal cover		
M25	H16B-SF-4B-MCV-M25	03016581321
2M25	H16B-SF-4B-MCV-2M25	03016586321
PG21	H16B-SF-4B-MCV-PG21	03016583621
2PG21	H16B-SF-4B-MCV-2PG21	03016588621

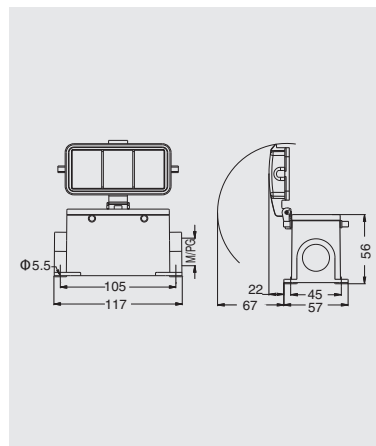

Housings, surface mounting

high construction



Thread	Designation	Order No.
M32	H16B-SFH-4B-M32	03016681410
2M32	H16B-SFH-4B-2M32	03016686410
PG21	H16B-SFH-4B-PG21	03016683610
2PG21	H16B-SFH-4B-2PG21	03016688610
PG21	H16B-SFH-4B-PG29	03016683710
2PG21	H16B-SFH-4B-2PG29	03016688710
with plastic cover		
M32	H16B-SFH-4B-CV-M32	03016681420
2M32	H16B-SFH-4B-CV-2M32	03016686420
PG21	H16B-SFH-4B-CV-PG21	03016683620
2PG21	H16B-SFH-4B-CV-2PG21	03016688620
PG29	H16B-SFH-4B-CV-PG29	03016683720
2PG29	H16B-SFH-4B-CV-2PG29	03016688720
with metal cover		
M32	H16B-SFH-4B-MCV-M32	03016681421
2M32	H16B-SFH-4B-MCV-2M32	03016686421
PG21	H16B-SFH-4B-MCV-PG21	03016683621
2PG21	H16B-SFH-4B-MCV-2PG21	03016688621
PG29	H16B-SFH-4B-MCV-PG29	03016683721
2PG29	H16B-SFH-4B-MCV-2PG29	03016688721

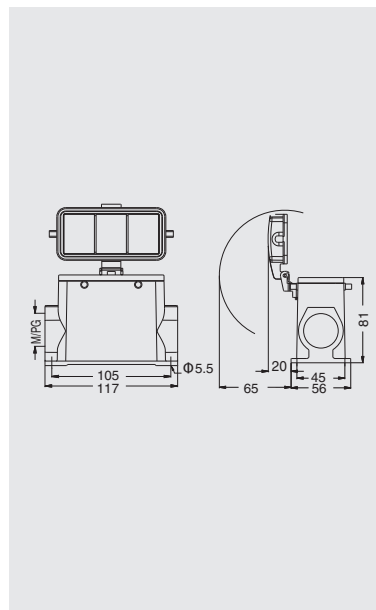

Protection covers, metal



Connect way	Application	Designation	Order No.
	for hoods	H16B-MCV-4B/1	03016398011
	for housings	H16B-MCV-4B/2	03016398021

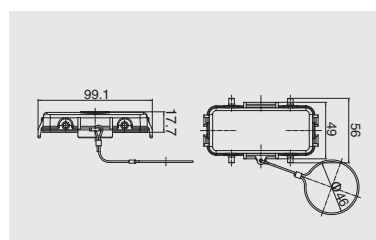

Protection covers, metal



Connect way	Application	Designation	Order No.
	for hoods	H16B-MCV-2L/PSR.1S	03016392052
	for housings	H16B-MCV-2L/PSR.2	03016392053

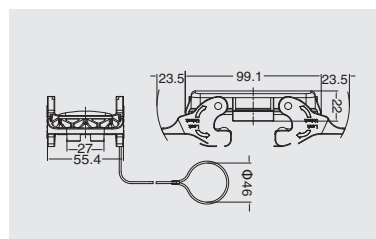

Please refer to page 16-02 for choosing proper model of lock.

16B Metal hoods/housings

Degree of protection: IP65

Hoods, side entry, high construction



Thread	Designation	Order No.
M32	H16B-SEH-1L/C-M32	03016311446
PG21	H16B-SEH-1L/C-PG21	03016313646
PG29	H16B-SEH-1L/C-PG29	03016313746

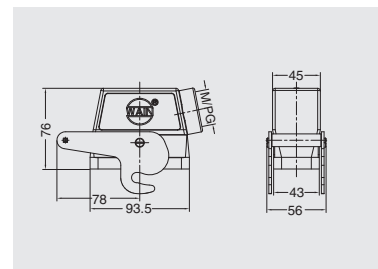

Housings, bulkhead mounting



Thread	Designation	Order No.
---	H16B-BK-2B/C	03016040030

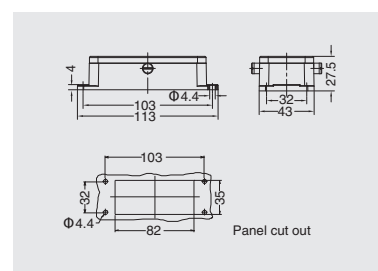

16B Pressure tight hoods/housings

Degree of protection: IP68

W version

Hoods, side entry, high construction

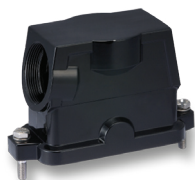

Thread	Designation	Order No.
M25	HP16B-SEH-2S-M25	04016351302
M32	HP16B-SEH-2S-M32	04016351402
M40	HP16B-SEH-2S-M40	04016351502
PG21	HP16B-SEH-2S-PG21	04016353602
PG29	HP16B-SEH-2S-PG29	04016353702

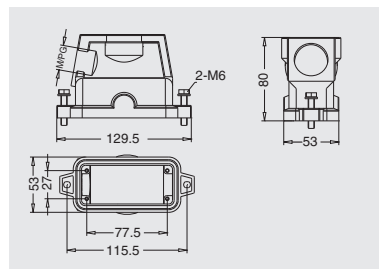

Hoods, top entry, high construction



Thread	Designation	Order No.
M25	HP16B-TEH-2S-M25	04016451302
M32	HP16B-TEH-2S-M32	04016451402
M40	HP16B-TEH-2S-M40	04016451502
M50	HP16B-TEH-2S-M50	04016451602
PG21	HP16B-TEH-2S-PG21	04016453602
PG29	HP16B-TEH-2S-PG29	04016453702

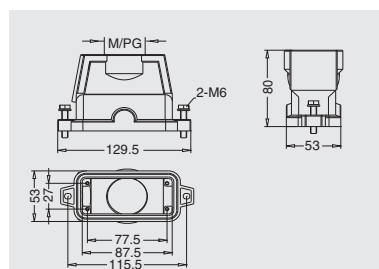

Housings, surface mounting



Thread	Designation	Order No.
M25	HP16B-SFH-2H-M25	04016611302
M32	HP16B-SFH-2H-M32	04016611402
M40	HP16B-SFH-2H-M40	04016551502
PG21	HP16B-SFH-2H-PG21	04016553602
PG29	HP16B-SFH-2H-PG29	04016553702

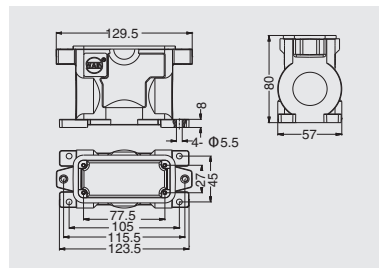

Housings, bulkhead mounting



Thread	Designation	Order No.
--	HP16B-BK-2H	04016050001

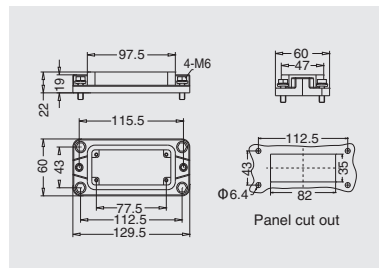

16B Pressure tight hoods/housings

Degree of protection: IP68

H version

Hoods, side entry, high construction



Thread	Designation	Order No.
	Screw locking	
M25	HP16B/H-SEH-2S-M25	04116351302
M32	HP16B/H-SEH-2S-M32	04116351402
M40	HP16B/H-SEH-2S-M40	04116351502
PG21	HP16B/H-SEH-2S-PG21	04116353602
PG29	HP16B/H-SEH-2S-PG29	04116353702
	Toggle locking	
M25	HP16B/H-SEH-2T-M25	04216351302
M32	HP16B/H-SEH-2T-M32	04216351402
M40	HP16B/H-SEH-2T-M40	04216351502
PG21	HP16B/H-SEH-2T-PG21	04216353602
PG29	HP16B/H-SEH-2T-PG29	04216353702

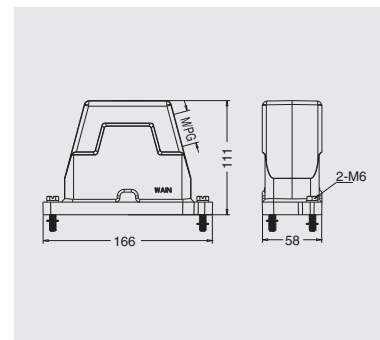

Hoods, top entry, high construction



Thread	Designation	Order No.
	Screw locking	
M25	HP16B/H-TEH-2S-M25	04116451302
M32	HP16B/H-TEH-2S-M32	04116451402
M40	HP16B/H-TEH-2S-M40	04116451502
M50	HP16B/H-TEH-2S-M50	04116451602
PG21	HP16B/H-TEH-2S-PG21	04116453602
PG29	HP16B/H-TEH-2S-PG29	04116453702
PG36	HP16B/H-TEH-2S-PG36	04116453802
	Toggle locking	
M25	HP16B/H-TEH-2T-M25	04216451302
M32	HP16B/H-TEH-2T-M32	04216451402
M40	HP16B/H-TEH-2T-M40	04216451502
M50	HP16B/H-TEH-2T-M50	04216451602
PG21	HP16B/H-TEH-2T-PG21	04216453602
PG29	HP16B/H-TEH-2T-PG29	04216453702
PG36	HP16B/H-TEH-2T-PG36	04216453802

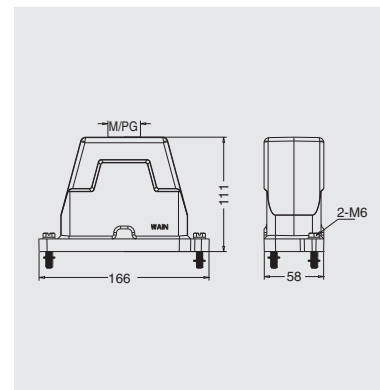

Housings, surface mounting

high construction



Thread	Designation	Order No.
	Screw locking	
M25	HP16B/H-SFH-2H-M25	04116611302
M32	HP16B/H-SFH-2H-M32	04116611402
M40	HP16B/H-SFH-2H-M40	04116611502
PG21	HP16B/H-SFH-2H-PG21	04116613602
PG29	HP16B/H-SFH-2H-PG29	04116613702
	Toggle locking	
M25	HP16B/H-SFH-2T-M25	04216611302
M32	HP16B/H-SFH-2T-M32	04216611402
M40	HP16B/H-SFH-2T-M40	04216611502
PG21	HP16B/H-SFH-2T-PG21	04216613602
PG29	HP16B/H-SFH-2T-PG29	04216613702

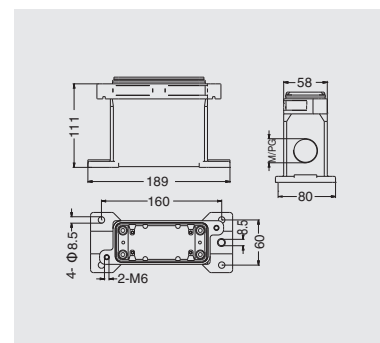

Housings, bulkhead mounting



Thread	Designation	Order No.
	Screw locking	
---	HP16B/H-BK-2H	04116050002
	Toggle locking	
---	HP16B/H-BK-2T	04216050002

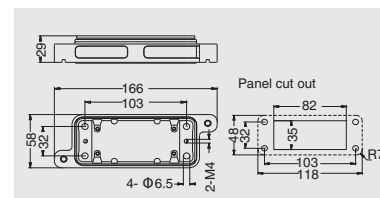

Protection covers



Thread	Designation	Order No.
	Screw locking	
---	HP16B/H-MCV-2S	04116390002
	Toggle locking	
---	HP16B/H-MCV-2T	04216390002

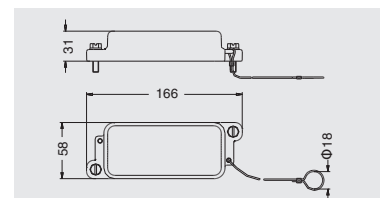

16B Pressure tight hoods/housings

Degree of protection: IP68

H version

Hoods, side entry, high construction

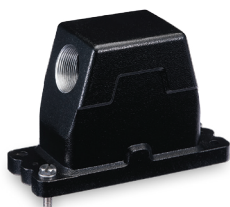

Thread	Designation	Order No.
M25	HP16B/H-SEH-4S-M25	04116361302
M32	HP16B/H-SEH-4S-M32	04116361402
M40	HP16B/H-SEH-4S-M40	04116361502
PG21	HP16B/H-SEH-4S-PG21	04116363602
PG29	HP16B/H-SEH-4S-PG29	04116363702

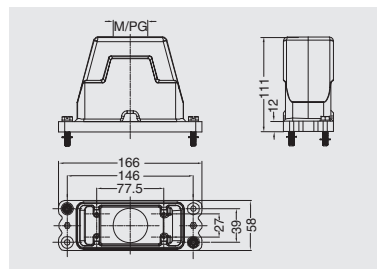

Hoods, top entry, high construction

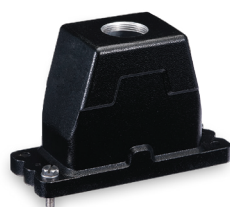

Thread	Designation	Order No.
M25	HP16B/H-TEH-4S-M25	04116461302
M32	HP16B/H-TEH-4S-M32	04116461402
M40	HP16B/H-TEH-4S-M40	04116461502
M50	HP16B/H-TEH-4S-M50	04116461602
PG21	HP16B/H-TEH-4S-PG21	04116463602
PG29	HP16B/H-TEH-4S-PG29	04116463702
PG36	HP16B/H-TEH-4S-PG36	04116463802

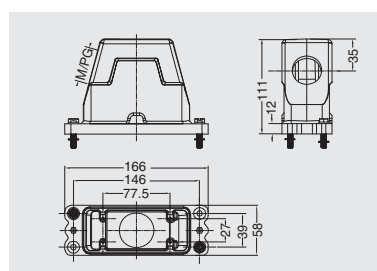

Housings, bulkhead mounting



Thread	Designation	Order No.
---	HP16B/H-BK-4H	04116060002

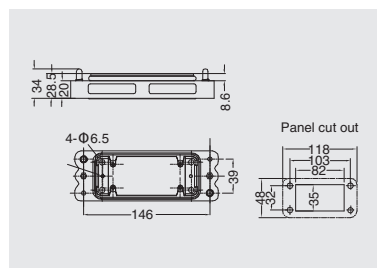

16B Pressure tight hoods/housings

Degree of protection: IP68

Hoods, top entry, high construction

EMC version

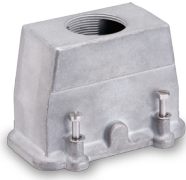

Thread	Designation	Order No.
M32	EMC-H16B-TEH-4S-M32	05216481410
M40	EMC-H16B-TEH-4S-M40	05216481510
PG21	EMC-H16B-TEH-4S-PG21	05216483610
PG29	EMC-H16B-TEH-4S-PG29	05216483710

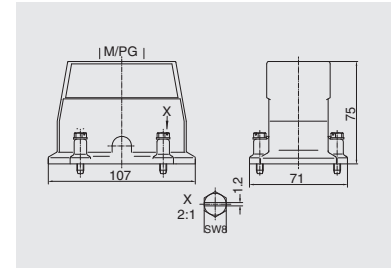

Housings, bulkhead mounting

EMC version



Thread	Designation	Order No.
---	EMC-H16B-BK-4H	05216080010

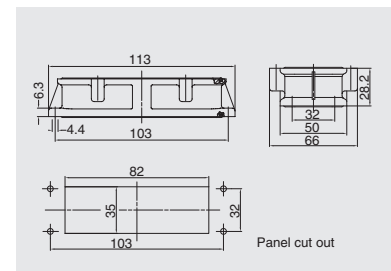

Hoods, side entry, high construction



Thread	Designation	Order No.
M32	HC16B-SEH-2S-M32	04216351401
M40	HC16B-SEH-2S-M40	04216351501
PG21	HC16B-SEH-2S-PG21	04216353601
PG29	HC16B-SEH-2S-PG29	04216353701

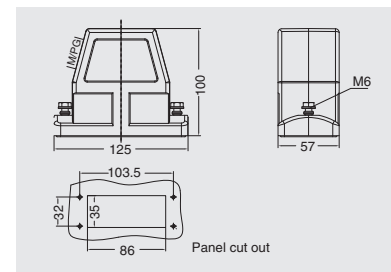

Hoods, top entry, high construction



Thread	Designation	Order No.
M32	HC16B-TEH-2S-M32	04216451401
M40	HC16B-TEH-2S-M40	04216451501
PG21	HC16B-TEH-2S-PG21	04216453601
PG29	HC16B-TEH-2S-PG29	04216453701

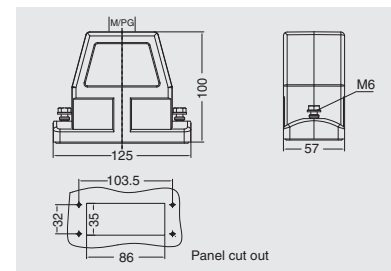

Protection covers



Application	Designation	Order No.
for integral type hoods	APT-C	08139140000

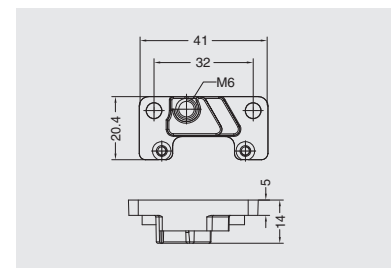

HV16B Metal hoods/housings
- for high voltage inserts(HVE Series)

Degree of protection: IP65

Hoods, side entry



Thread	Designation	Order No.
M25	HV16B-SE-2B-M25	05016141310
PG21	HV16B-SE-2B-PG21	05016143610

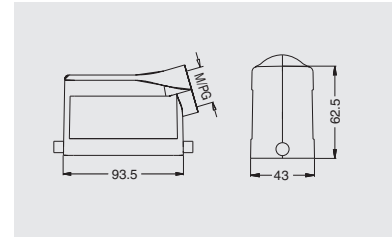

Hoods, side entry, high construction



Thread	Designation	Order No.
M32	HV16B-SEH-2B-M32	05016341410
M40	HV16B-SEH-2B-M40	05016341510
PG21	HV16B-SEH-2B-PG21	05016343610
PG29	HV16B-SEH-2B-PG29	05016343710

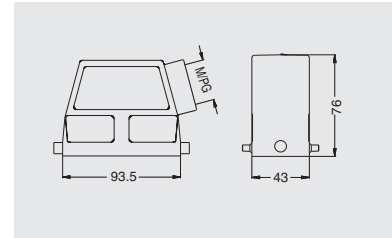

Hoods, top entry



Thread	Designation	Order No.
M25	HV16B-TE-2B-M25	05016241310
M32	HV16B-TE-2B-M32	05016241410
PG21	HV16B-TE-2B-PG21	05016243610

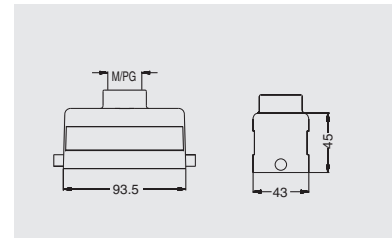

Hoods, top entry, high construction



Thread	Designation	Order No.
M32	HV16B-TEH-2B-M32	05016441410
M40	HV16B-TEH-2B-M40	05016441510
PG21	HV16B-TEH-2B-PG21	05016443610
PG29	HV16B-TEH-2B-PG29	05016443710

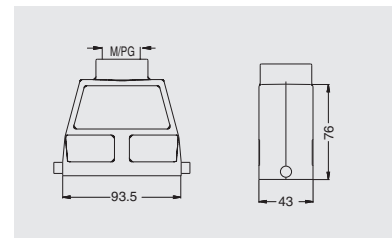

Housings, cable to cable



Thread	Designation	Order No.
M25	HV16B-CCT-1L/PSR-M25	05016711352
PG21	HV16B-CCT-1L/PSR-PG21	05016713652

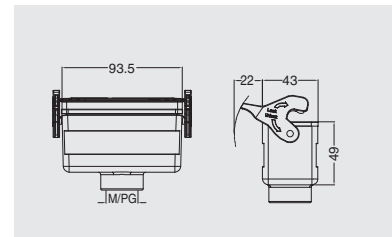

Please refer to page 16-02 for choosing proper model of lock.

Housings, cable to cable
high construction



Thread	Designation	Order No.
M32	HV16B-CCTH-1L/PSR-M32	05016811452
M40	HV16B-CCTH-1L/PSR-M40	05016811552
PG21	HV16B-CCTH-1L/PSR-PG21	05016813652
PG29	HV16B-CCTH-1L/PSR-PG29	05016813752

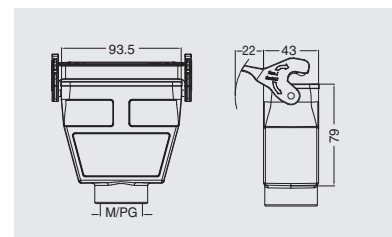

Please refer to page 16-02 for choosing proper model of lock.

HV16B Metal hoods/housings
- for high voltage inserts(HVE Series)

Degree of protection: IP65

Housings, bulkhead mounting



Thread	Designation	Order No.
---	HV16B-BK-1L/PSR	05016010052
	with plastic cover	
---	HV16B-BK-1L/PSR-CV	05016010062
	with metal cover	
---	HV16B-BK-1L/PSR-MCV	05016010063

Please refer to page 16-02 for choosing proper model of lock.

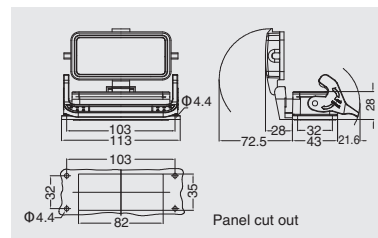

Panel cut out

Housings, surface mounting



Thread	Designation	Order No.
M25	HV16B-SF-1L/PSR-M25	05016511352
2M25	HV16B-SF-1L/PSR-2M25	05016516352
PG21	HV16B-SF-1L/PSR-PG21	05016513652
2PG21	HV16B-SF-1L/PSR-2PG21	05016518652
	with plastic cover	
M25	HV16B-SF-1L/PSR-CV-M25	05016511363
2M25	HV16B-SF-1L/PSR-CV-2M25	05016516363
PG21	HV16B-SF-1L/PSR-CV-PG21	05016513663
2PG21	HV16B-SF-1L/PSR-CV-2PG21	05016518663
	with metal cover	
M25	HV16B-SF-1L/PSR-MCV-M25	05016511364
2M25	HV16B-SF-1L/PSR-MCV-2M25	05016516364
PG21	HV16B-SF-1L/PSR-MCV-PG21	05016513664
2PG21	HV16B-SF-1L/PSR-MCV-2PG21	05016518664

Please refer to page 16-02 for choosing proper model of lock.

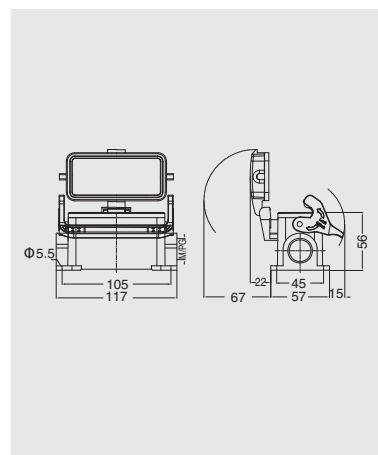

Housings, surface mounting

high construction



Thread	Designation	Order No.
M32	HV16B-SFH-1L/PSR-M32	05016611452
2M32	HV16B-SFH-1L/PSR-2M32	05016616452
PG21	HV16B-SFH-1L/PSR-PG21	05016613652
2PG21	HV16B-SFH-1L/PSR-2PG21	05016618652
PG29	HV16B-SFH-1L/PSR-PG29	05016613752
2PG29	HV16B-SFH-1L/PSR-2PG29	05016618752
	with plastic cover	
M32	HV16B-SFH-1L/PSR-CV-M32	05016611463
2M32	HV16B-SFH-1L/PSR-CV-2M32	05016616463
PG21	HV16B-SFH-1L/PSR-CV-PG21	05016613663
2PG21	HV16B-SFH-1L/PSR-CV-2PG21	05016618663
PG29	HV16B-SFH-1L/PSR-CV-PG29	05016613763
2PG29	HV16B-SFH-1L/PSR-CV-2PG29	05016618763
	with metal cover	
M32	HV16B-SFH-1L/PSR-MCV-M32	05016611464
2M32	HV16B-SFH-1L/PSR-MCV-2M32	05016616464
PG21	HV16B-SFH-1L/PSR-MCV-PG21	05016613664
2PG21	HV16B-SFH-1L/PSR-MCV-2PG21	05016618664
PG29	HV16B-SFH-1L/PSR-MCV-PG29	05016613764
2PG29	HV16B-SFH-1L/PSR-MCV-2PG29	05016618764

Please refer to page 16-02 for choosing proper model of lock.

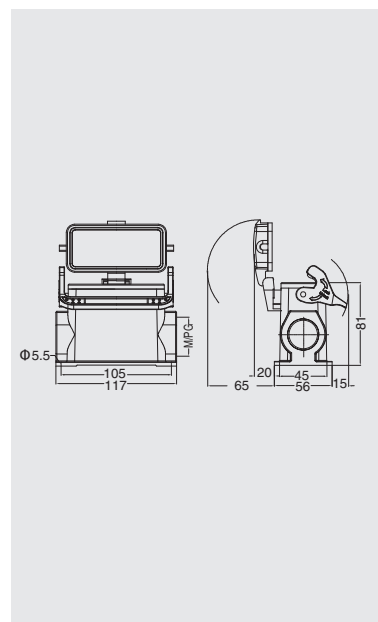

HV16B Metal hoods/housings
- for high voltage inserts(HVE Series)

Degree of protection: IP65

Hoods, side entry



Thread	Designation	Order No.
M25	HV16B-SE-4B-M25	05016181310
M32	HV16B-SE-4B-M32	05016181410
PG21	HV16B-SE-4B-PG21	05016183610

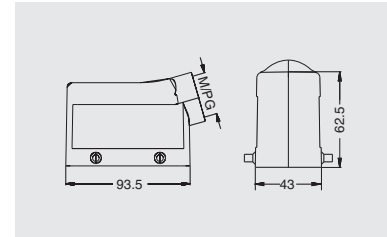

Hoods, side entry, high construction



Thread	Designation	Order No.
M32	HV16B-SEH-4B-M32	05016381410
M40	HV16B-SEH-4B-M40	05016381510
PG21	HV16B-SEH-4B-PG21	05016383610
PG29	HV16B-SEH-4B-PG29	05016383710

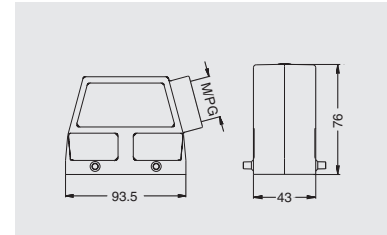

Hoods, top entry



Thread	Designation	Order No.
M25	HV16B-TE-4B-M25	05016281310
PG21	HV16B-TE-4B-PG21	05016283610

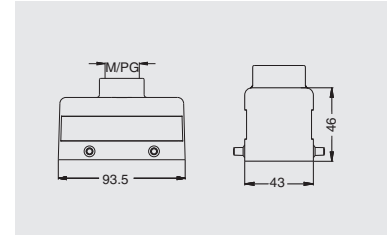

Hoods, top entry, high construction



Thread	Designation	Order No.
M32	HV16B-TEH-4B-M32	05016481410
M40	HV16B-TEH-4B-M40	05016481510
PG21	HV16B-TEH-4B-PG21	05016483610
PG29	HV16B-TEH-4B-PG29	05016483710

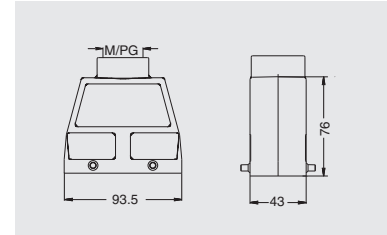

Housings, bulkhead mounting



Thread	Designation	Order No.
--	HV16B-BK-2L/PSR	05016020052

Please refer to page 16-02 for choosing proper model of lock.

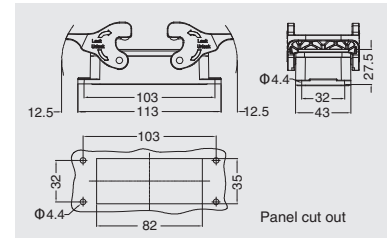

Housings, surface mounting



Thread	Designation	Order No.
M25	HV16B-SF-2L/PSR-M25	05016521352
2M25	HV16B-SF-2L/PSR-2M25	05016526352
PG21	HV16B-SF-2L/PSR-PG21	05016523652
2PG21	HV16B-SF-2L/PSR-2PG21	05016528652

Please refer to page 16-02 for choosing proper model of lock.

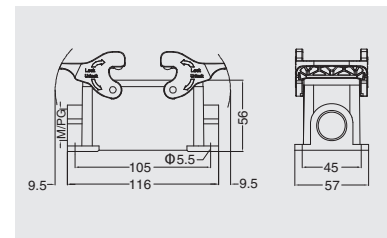

HV16B Metal hoods/housings
- for high voltage inserts(HVE Series)

Degree of protection: IP65

Housings, surface mounting

high construction



Thread	Designation	Order No.
M32	HV16B-SFH-2L/PSR-M32	05016621452
2M32	HV16B-SFH-2L/PSR-2M32	05016626452
PG21	HV16B-SFH-2L/PSR-PG21	05016623652
2PG21	HV16B-SFH-2L/PSR-2PG21	05016628652
PG29	HV16B-SFH-2L/PSR-PG29	05016623752
2PG29	HV16B-SFH-2L/PSR-2PG29	05016628752

Please refer to page 16-02 for choosing proper model of lock.

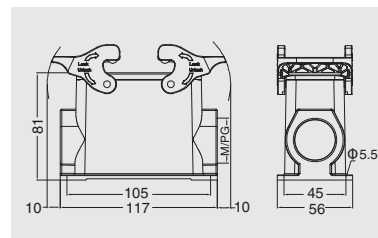

Housings, cable to cable

high construction



Thread	Designation	Order No.
M25	HV16B-CCT-2L/PSR-M25	05016721352
PG21	HV16B-CCT-2L/PSR-PG21	05016723652

Please refer to page 16-02 for choosing proper model of lock.

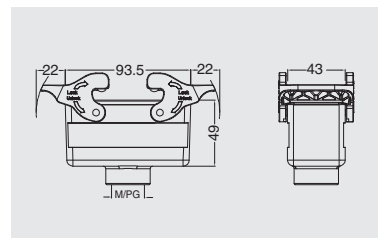

Housings, cable to cable



Thread	Designation	Order No.
M32	HV16B-CCTH-2L/PSR-M32	05016821452
M40	HV16B-CCTH-2L/PSR-M40	05016821552
PG21	HV16B-CCTH-2L/PSR-PG21	05016823652
PG29	HV16B-CCTH-2L/PSR-PG29	05016823752

Please refer to page 16-02 for choosing proper model of lock.

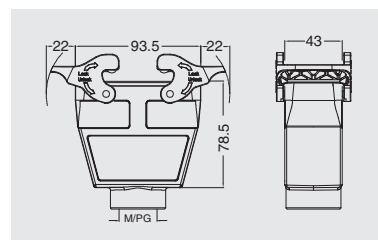

Protection covers, plastic



Connect way	Application	Designation	Order No.
--	for hoods	H16B-CV-4C	08221233000

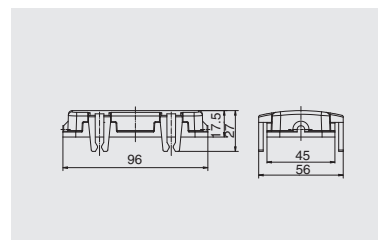

Protection covers, plastic



Connect way	Application	Designation	Order No.
	for hoods	H16B-CV-4B/1	08221232011
	for housings	H16B-CV-4B/2	08221232020

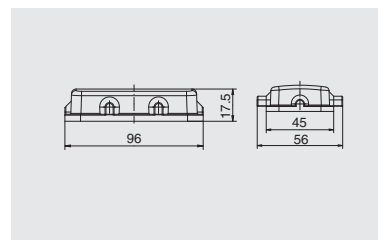

HV16B Metal hoods/housings
- for high voltage inserts(HVE Series)

Degree of protection: IP65

Hoods, side entry



Thread	Designation	Order No.
M25	HV16B-SE-2L/PSR-M25	05016121352
M32	HV16B-SE-2L/PSR-M32	05016121452
PG21	HV16B-SE-2L/PSR-PG21	05016123652

Please refer to page 16-02 for choosing proper model of lock.

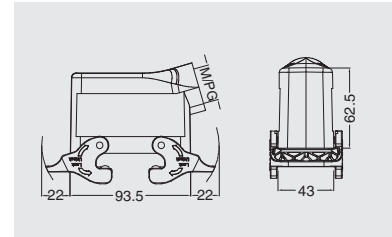

Hoods, side entry, high construction



Thread	Designation	Order No.
M32	HV16B-SEH-2L/PSR-M32	05016321452
M40	HV16B-SEH-2L/PSR-M40	05016321552
PG21	HV16B-SEH-2L/PSR-PG21	05016323652
PG29	HV16B-SEH-2L/PSR-PG29	05016323752

Please refer to page 16-02 for choosing proper model of lock.

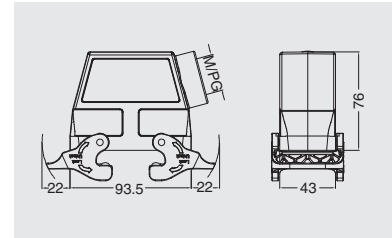

Hoods, top entry



Thread	Designation	Order No.
M25	HV16B-TE-2L/PSR-M25	05016221352
PG21	HV16B-TE-2L/PSR-PG21	05016223652

Please refer to page 16-02 for choosing proper model of lock.

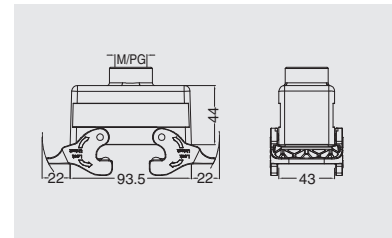

Hoods, top entry, high construction



Thread	Designation	Order No.
M32	HV16B-TEH-2L/PSR-M32	05016421452
M40	HV16B-TEH-2L/PSR-M40	05016421552
PG21	HV16B-TEH-2L/PSR-PG21	05016423652
PG29	HV16B-TEH-2L/PSR-PG29	05016423752

Please refer to page 16-02 for choosing proper model of lock.

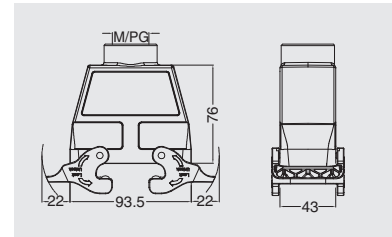

Housings, bulkhead mounting



Thread	Designation	Order No.
—	HV16B-BK-4B	05016080010
	with plastic cover	
	HV16B-BK-4B-CV	05016080020
	with metal cover	
	HV16B-BK-4B-MCV	05016080021

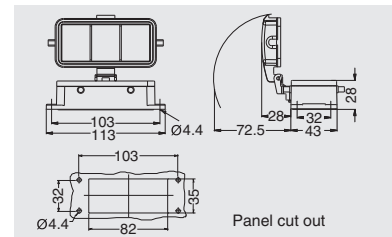

HV16B Metal hoods/housings
- for high voltage inserts(HVE Series)

Degree of protection: IP65

Housings, surface mounting



Thread	Designation	Order No.
M25	HV16B-SF-4B-M25	05016581310
2M25	HV16B-SF-4B-2M25	05016586310
PG21	HV16B-SF-4B-PG21	05016583610
2PG21	HV16B-SF-4B-2PG21	05016588610
with plastic cover		
M25	HV16B-SF-4B-CV-M25	05016581320
2M25	HV16B-SF-4B-CV-2M25	05016586320
PG21	HV16B-SF-4B-CV-PG21	05016583620
2PG21	HV16B-SF-4B-CV-2PG21	05016588620
with metal cover		
M25	HV16B-SF-4B-MCV-M25	05016581321
2M25	HV16B-SF-4B-MCV-2M25	05016586321
PG21	HV16B-SF-4B-MCV-PG21	05016583621
2PG21	HV16B-SF-4B-MCV-2PG21	05016588621

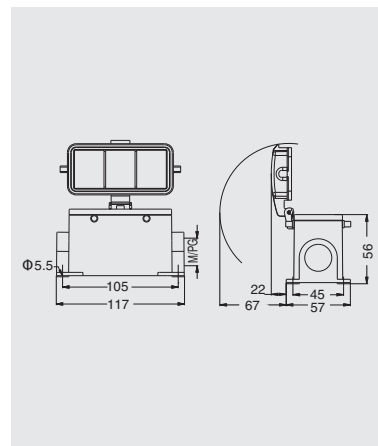

Housings, surface mounting
high construction

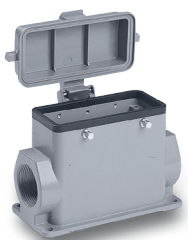

Thread	Designation	Order No.
M32	HV16B-SFH-4B-M32	05016681410
2M32	HV16B-SFH-4B-2M32	05016686410
PG21	HV16B-SFH-4B-PG21	05016683610
2PG21	HV16B-SFH-4B-2PG21	05016688610
PG29	HV16B-SFH-4B-PG29	05016683710
2PG29	HV16B-SFH-4B-2PG29	05016688710
with plastic cover		
M32	HV16B-SFH-4B-CV-M32	05016681420
2M32	HV16B-SFH-4B-CV-2M32	05016686420
PG21	HV16B-SFH-4B-CV-PG21	05016683620
2PG21	HV16B-SFH-4B-CV-2PG21	05016688620
PG29	HV16B-SFH-4B-CV-PG29	05016683720
2PG29	HV16B-SFH-4B-CV-2PG29	05016688720
with metal cover		
M32	HV16B-SFH-4B-MCV-M32	05016681421
2M32	HV16B-SFH-4B-MCV-2M32	05016686421
PG21	HV16B-SFH-4B-MCV-PG21	05016683621
2PG21	HV16B-SFH-4B-MCV-2PG21	05016688621
PG29	HV16B-SFH-4B-MCV-PG29	05016683721
2PG29	HV16B-SFH-4B-MCV-2PG29	05016688721

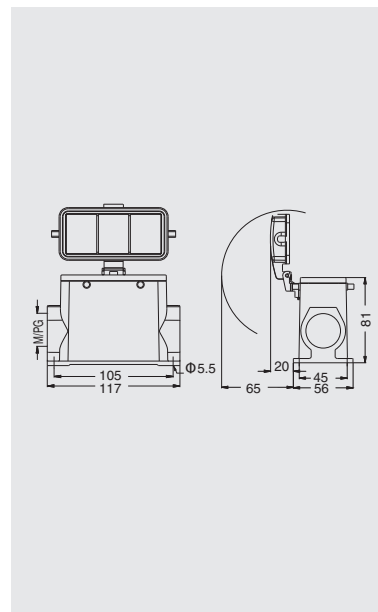

Protection covers, metal



Connect way	Application	Designation	Order No.
	for hoods	H16B-MCV-4B/1	03016398011
	for housings	H16B-MCV-4B/2	03016398021

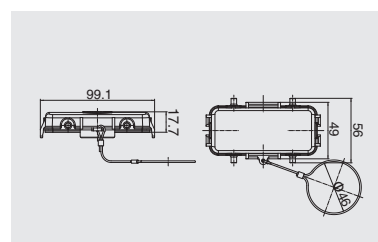

Protection covers, metal



Connect way	Application	Designation	Order No.
	for hoods	H16B-MCV-2L/PSR.IS	03016392052
	for housings	H16B-MCV-2L/PSR.2	03016392053

Please refer to page 16-02 for choosing proper model of lock.

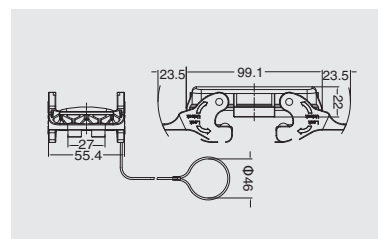

HV16B Metal hoods/housings
 - for high voltage inserts(HVE Series)

Degree of protection: IP65

Hoods, side entry, high construction



Thread	Designation	Order No.
M32	HV16B-SEH-1L/C-M32	05016311446
PG21	HV16B-SEH-1L/C-PG21	05016313646
PG29	HV16B-SEH-1L/C-PG29	05016313746

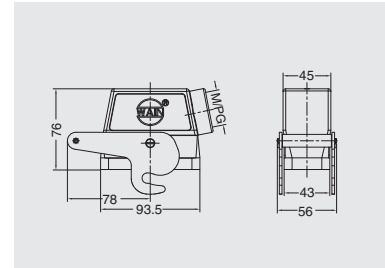

Housings, bulkhead mounting



Thread	Designation	Order No.
---	HV16B-BK-2B/C	05016040030

