

## 10A Metal hoods/housings

Degree of protection: IP65

### Hoods, side entry



Thread	Designation	Order No.
M20	H10A-SE-2B-M20	02010141210
PG16	H10A-SE-2B-PG16	02010143510

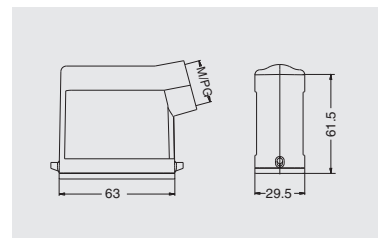

### Hoods, side entry, high construction



Thread	Designation	Order No.
M25	H10A-SEH-2B-M25	02010341310
PG16	H10A-SEH-2B-PG16	02010343510
PG21	H10A-SEH-2B-PG21	02010343610

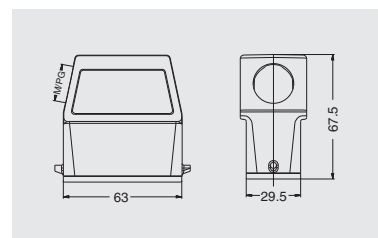

### Hoods, top entry



Thread	Designation	Order No.
M20	H10A-TE-2B-M20	02010241210
PG13.5	H10A-TE-2B-PG13.5	02010243410

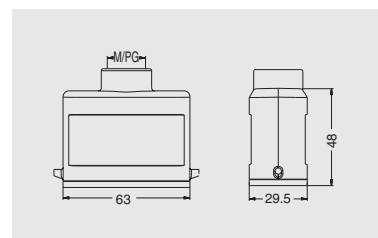

### Hoods, top entry, high construction



Thread	Designation	Order No.
M25	H10A-TEH-2B-M25	02010441310
PG16	H10A-TEH-2B-PG16	02010443510
PG21	H10A-TEH-2B-PG21	02010443610

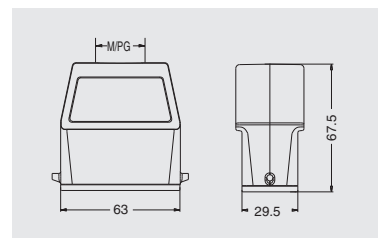

### Housings, bulkhead mounting



Thread	Designation	Order No.
--	H10A-BK-1L/PSR with plastic cover	02010010052
--	H10A-BK-1L/PSR-CV with metal cover	02010010063
--	H10A-BK-1L/PSR-MCV	02010010064

Please refer to page 16-02 for choosing proper model of lock.

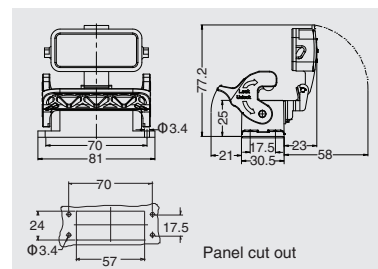

# 10A Metal hoods/housings

Degree of protection: IP65

Housings, surface mounting



Thread	Designation	Order No.
M20	H10A-SF-1L/PSR-M20	02010511252
2M20	H10A-SF-1L/PSR-2M20	02010516252
M25	H10A-SF-1L/PSR-M25	02010511352
PG16	H10A-SF-1L/PSR-PG16	02010513552
2PG16	H10A-SF-1L/PSR-2PG16	02010518552
PG21	H10A-SF-1L/PSR-PG21	02010513652
with plastic cover		
M20	H10A-SF-1L/PSR-CV-M20	02010511263
2M20	H10A-SF-1L/PSR-CV-2M20	02010516263
M25	H10A-SF-1L/PSR-CV-M25	02010511363
PG16	H10A-SF-1L/PSR-CV-PG16	02010513563
2PG16	H10A-SF-1L/PSR-CV-2PG16	02010518563
PG21	H10A-SF-1L/PSR-CV-PG21	02010513663
with metal cover		
M20	H10A-SF-1L/PSR-MCV-M20	02010511264
2M20	H10A-SF-1L/PSR-MCV-2M20	02010516264
M25	H10A-SF-1L/PSR-MCV-M25	02010511364
PG16	H10A-SF-1L/PSR-MCV-PG16	02010513564
2PG16	H10A-SF-1L/PSR-MCV-2PG16	02010518564
PG21	H10A-SF-1L/PSR-MCV-PG21	02010513664

Please refer to page 16-02 for choosing proper model of lock.

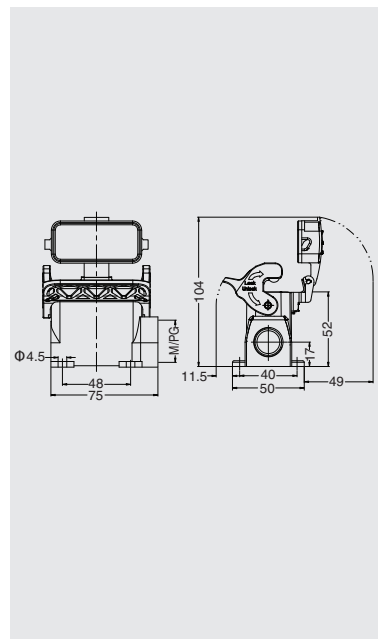

Protection covers, metal cover



Connect way	Applications	Designation	Order No.
	for hoods	H10A-MCV-1L/PSR.1	08139111002

Please refer to page 16-02 for choosing proper model of lock.

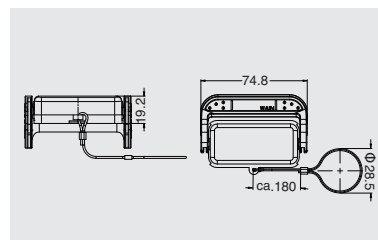

Protection covers, metal cover



Connect way	Applications	Designation	Order No.
	for housings	H10A-MCV-2B/1S	08139110100
	for housings	H10A-MCV-2B/2S	08139110000

